

# Introduction to **Tog-L-Loc**<sup>®</sup>

An overview of BTM's Tog-L-Loc<sup>®</sup> sheet metal clinching system.

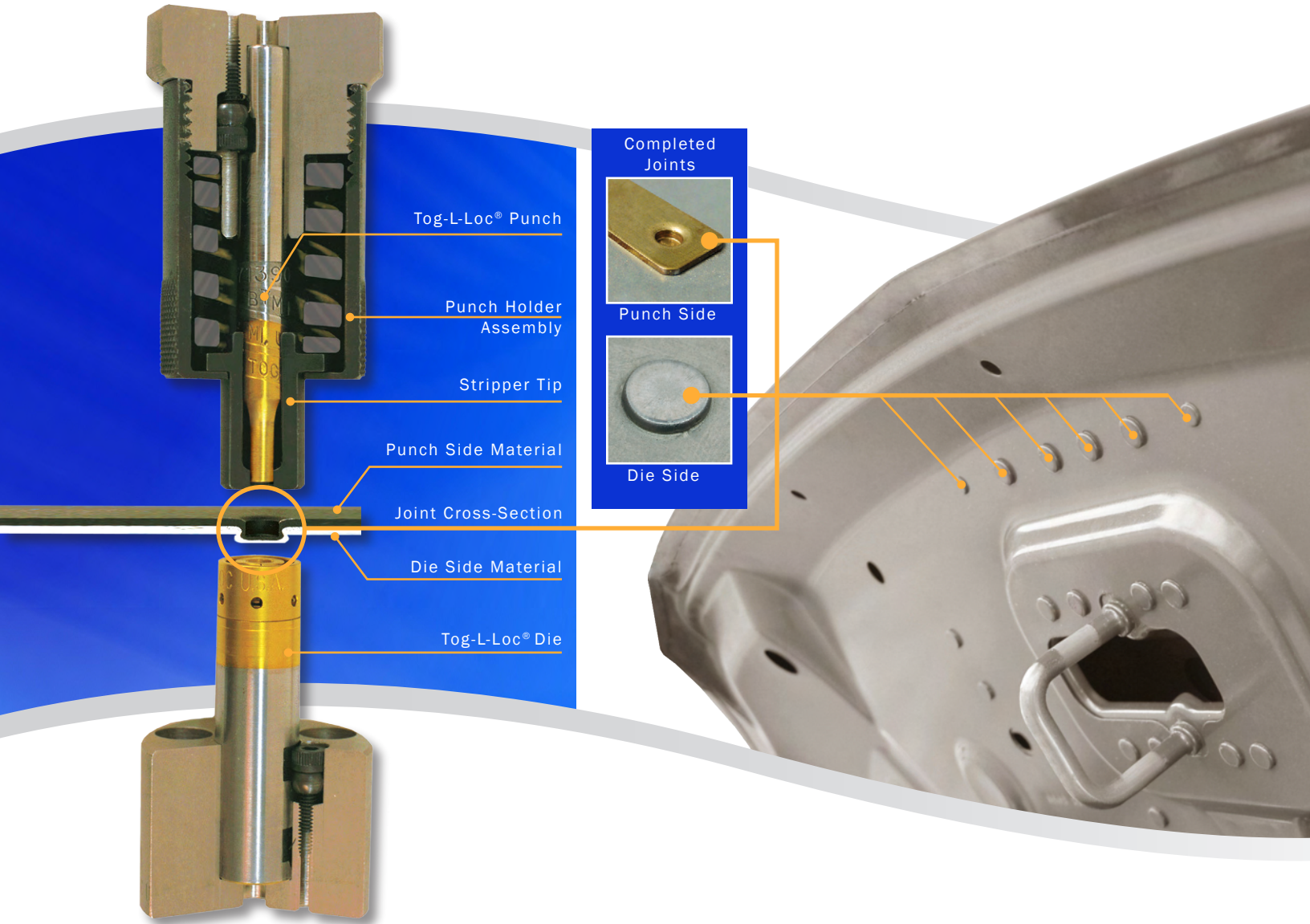

**BTM**<sup>®</sup>  
CORPORATION

[www.BTMcorp.com](http://www.BTMcorp.com)

810-364-4567

# INTRODUCING Tog-L-Loc<sup>®</sup> (pronounced: tog-uhl-löck)

Tog-L-Loc<sup>®</sup> is BTM Corporation's patented sheet metal clinching process. A special punch and die are used to form a strong interlocking joint within the metals themselves. The result of the process is a round, button shaped extrusion on the die side of the assembly, and a small cylindrical cavity on the punch side. The joint is comprised wholly of the sheet metals that were joined -no additional fasteners or welding is required. In fact, Tog-L-Loc<sup>®</sup> often replaces these traditional fastening techniques in an assembly, due to the repeatability and cost-effectiveness of the process.

## How a Tog-L-Loc joint is made:

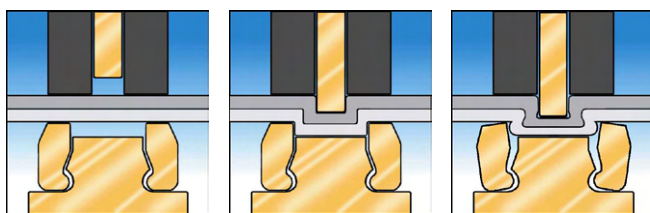

**Step 1: Clamp**

**Step 2: Draw**

**Step 3: Lock**

### Step 1: Clamps

The stripper clamps the sheet metal parts to be joined.

### Step 2: Draws

The punch draws the sheet metal into the die and the metals expand when they hit the die anvil.

### Step 3: Locks

The metals, unable to continue their downward expansion, are compressed against the anvil and are forced to expand laterally, forming an interlock below the bottom sheet. The die blades expand, allowing this interlock to occur.

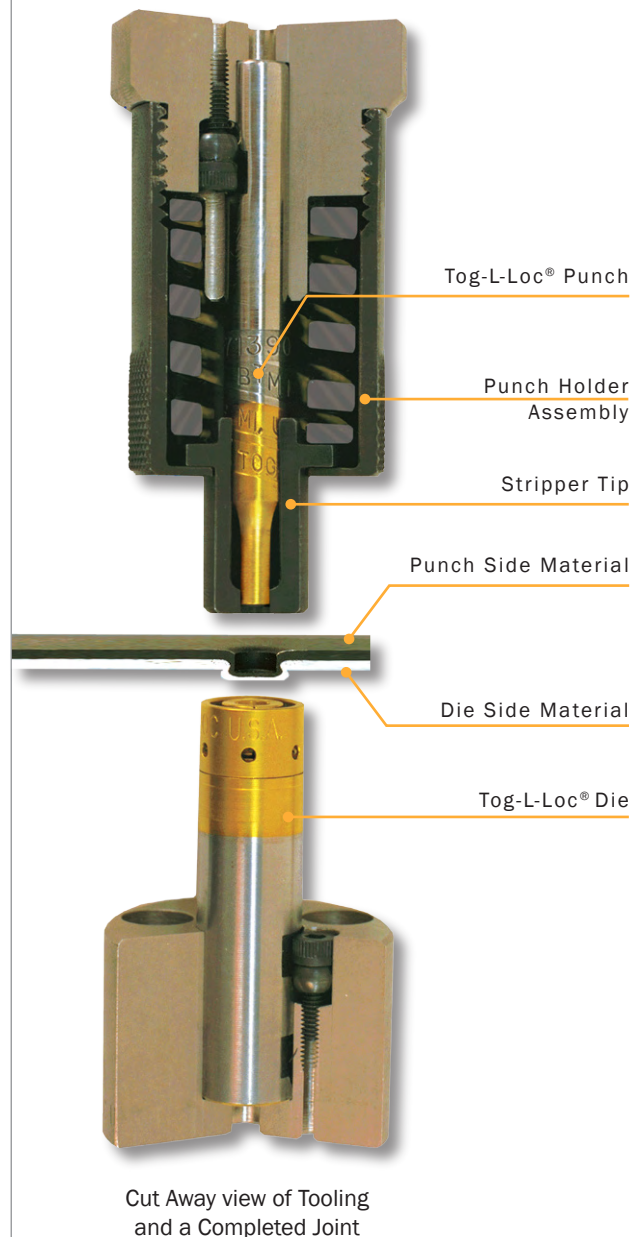

Cut Away view of Tooling and a Completed Joint

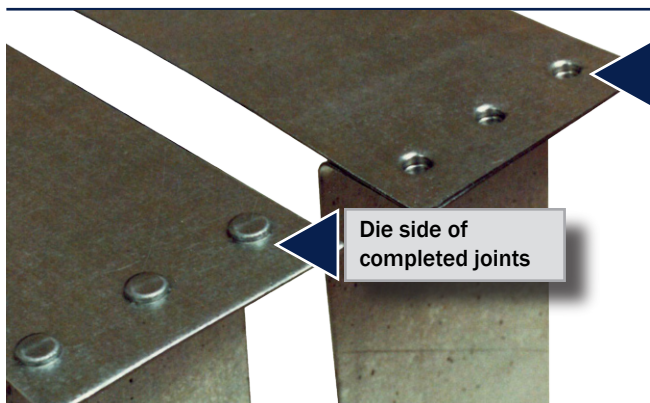

Cut away view of a completed Tog-L-Loc<sup>®</sup> joint. Notice how the metal flow has formed an interlock.

# TABLE OF CONTENTS

## BENEFITS OF TOG-L-LOC®

Natural Benefits (Environmentally Friendly) .....	4
Tog-L-Loc® vs. Welding & Riveting .....	5

## EXAMPLES OF TOG-L-LOC®

Automotive .....	6-7
HVAC .....	8-9
Building Supply .....	10-11
Electronics .....	12-13
Appliance .....	14-15

## IS TOG-L-LOC® RIGHT FOR YOUR ASSEMBLY?

Can your material be clinched? .....	16
Is there enough room to make a joint? .....	16
Joint strength & tool size .....	17
Testing .....	17
Getting Started .....	17

## TOG-L-LOC® TOOLING

Standard Die Styles .....	18
Standard Punch Styles .....	18
Standard Die Holders .....	19
Standard Punch Holders .....	19

## PRODUCTION EQUIPMENT

Press Brake Tooling .....	20
Die Sets .....	20
Hand Held Units .....	20
Universal Presses .....	20
Specialized Units .....	20
Special Fixtures .....	20
Custom Machine Solutions .....	21

## OTHER INNOVATIVE SOLUTIONS FOR ASSEMBLY

Lance-N-Loc™ Sheet Metal Joining .....	22
Piercing .....	23
Shearing .....	23
Swaging .....	23

# Natural Benefits

The Tog-L-Loc® process is

## ENVIRONMENTALLY FRIENDLY

---

CLEAN • LOW ENERGY CONSUMPTION • LOW NOISE EMISSIONS

---

With concern for the environment becoming a major factor in consumer buying decisions around the world, it is now more important than ever to consider using assembly processes which are **environmentally friendly**.

BTM's Tog-L-Loc® sheet metal joining system can be very **environmentally friendly**, especially when the process is conducted by "green" production equipment. This is because Tog-L-Loc® is a cold forming clinch process. In other words, there are no sparks, fumes, or harmful heat emitted- even when joining galvanized or other coated materials- and because Tog-L-Loc® is a clinching process, no holes need to be tapped or drilled into the work piece, so no slugs or shavings are created when joining the metals.

Tog-L-Loc® can be environmentally friendly, but it can also be friendly toward your profit margin. Unlike many **green** products or processes which can cost a lot more than their traditional counterparts, the Tog-L-Loc® process can actually reduce assembly costs when compared to traditional fastening methods.

---

Help keep the planet (and your **profit margin**) healthy with

# Tog-L-Loc®

# NO FASTENERS.. & NO WELDS.. NO KIDDING

**Tog-L-Loc®** works independent of, and often replaces **spot welding** and **riveting**

## Tog-L-Loc® vs. Welding

Spot Welding has a number of disadvantages when compared with Tog-L-Loc®. To name just a few, welding can burn pre-painted or pre-coated surfaces, it creates toxic fumes from galvanized metals, and it can be difficult to effectively join aluminum. Tog-L-Loc® on the other hand can join metals with a range of coatings and keep them intact, Tog-L-Loc® does not emit harmful heat or noxious fumes even when joining galvanized metal, and tooling is available to clinch a range of aluminums, as well as dissimilar metal combinations. Besides these basic advantages, Tog-L-Loc® has been shown to offer a significant cost savings over spot welding. A report prepared for Ontario Hydro by Iain Campbell from the Centre for Advanced Technology Education<sup>1</sup> states "(Clinching) is more energy efficient than spot welding because the joint does not require heat and the high electrical current associated with spot welding." It goes on to say "The potential energy savings of clinching over resistance spot welding can be as high as 60%", and also mentions that "the quality of a clinched joint is more consistent than a comparable welded joint".

1. "Clinch Technology as a Replacement For Resistance Spot Welding"  
Iain Campbell - Center for Advanced Technical Education, Ryerson Polytechnical Institute.  
Prepared for Ontario Hydroelectric, Technical services Department. TSDD-91-054 / 1991

## Tog-L-Loc® vs. Riveting

Are you still Riveting? Do you need to? Each and every rivet has a cost associated with it. This cost alone can be quite high when compared with Tog-L-Loc®, as it is not uncommon for Tog-L-Loc® tooling to create over 300,000 joints before it needs to be replaced. This can mean significant savings, but when you consider that the process does not require any holes to be pierced, and can be accomplished with cost-effective production equipment, the savings can be even greater.

Contact BTM Corporation today to learn more about the cost-saving benefit of switching to Tog-L-Loc® for your sheet metal assembly needs!

## YOU CAN \$AVE MONEY BY SWITCHING TO TOG-L-LOC®

## Additional Benefits of Tog-L-Loc®

- Joins plain, coated, and dissimilar metals
- No rivets, screws, or other fasteners
- Eliminates spot welding operations
- Long tool life: 300,000 joints common
- Joins in a single press stroke
- Non-Destructive testing with a simple gage
- Strong and highly fatigue resistant
- Leakproof joints
- No sparks, fumes, or soot

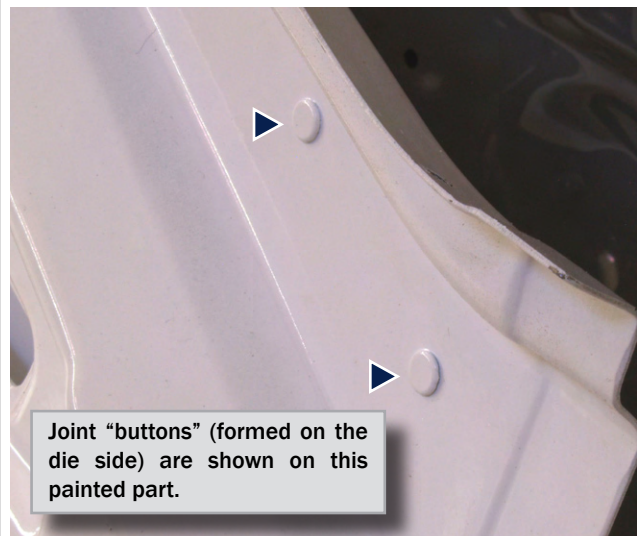



Hood Latch



**DID YOU KNOW ...**

*The hood, decklid, and other components can be joined with Tog-L-Loc®?*

Volvo is a trade name/trade mark of its respective owner.

Tog-L-Loc® is a viable alternative to spot welding or external fasteners on a number of automotive components. Tog-L-Loc® has been used for years to join a variety of parts including gas tank straps, exhaust shields, sunroof frames, package trays, brake pedal brackets, engine components, window trim, air conditioning components, air bag components, and more. Contact BTM to see if Tog-L-Loc® is right for your application.

**Package Tray**



**Gas Tank straps**



**Aluminized Steel Exhaust Shield**



**Laminated Sound Deadening Material**

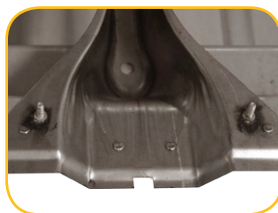

**Sunroof Frame**

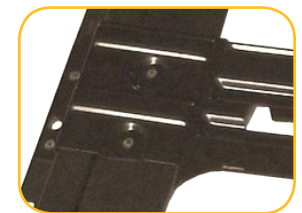

## Tog-L-Loc® in the Automotive Industry

With today's competitive manufacturing environment, automakers and their suppliers are looking for ways to cut costs without sacrificing quality, and Tog-L-Loc® has proven to be effective in doing just that. Since the 1980's, Tog-L-Loc® has assisted in the assembly of vehicles from all around the world by clinching a wide range of components, which include examples shown on these two pages. Aluminum, pre-painted metals, dissimilar metal combinations, and even galvanized steel can easily be joined using the Tog-L-Loc® sheet metal joining system, which is also prized for its, leak-proof joints, consistent joint strength, and its ability to be checked non-destructively with a simple gage.

Contact **BTM Corporation** today to schedule a **FREE** sample of your part joined with Tog-L-Loc!

### Let Tog-L-Loc® work for you.

When you contact BTM, our engineers will guide you through the Tog-L-Loc® process and work with you to develop a solution that is right for your own unique application. As an added benefit, if our engineers determine that Tog-L-Loc® is indeed a viable option for you, we can schedule a FREE sample joining of your part and provide joint data information.

Contact BTM Corporation to schedule a FREE sample joining of your part!

Gas Tank Shield

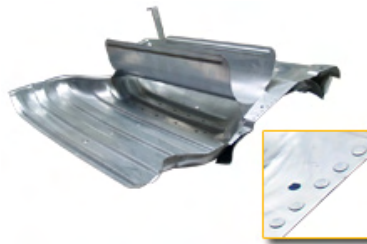

Gasket



Brackets



Air Conditioning Tube



### Brake Pedal Bracket Machine

This custom built three station system is used to create 16 Tog-L-Loc® joints and 4 pierced holes in a brake pedal bracket.

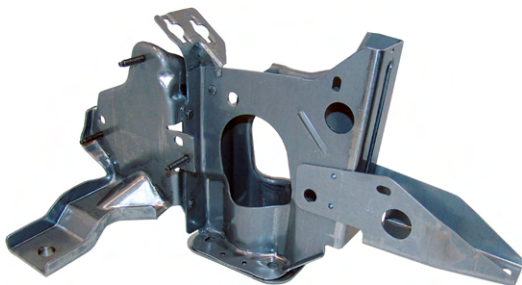



## Is your part made out of ***Galvanized Steel?***

### **Galvanized coating is no problem for Tog-L-Loc<sup>®</sup>!**

Galvanized steel is popular in the HVAC industry, but welding it is a health hazard. Perhaps because of this, traditional fasteners such as screws, bolts, and rivets have become a popular method to join galvanized parts over the years. Unfortunately the increased cost of using these fasteners in your assembly process deducts from your overall profits... So how then can you join your galvanized parts safely, effectively, and without the increased costs associated with the use of external fasteners?

### **Tog-L-Loc<sup>®</sup> is your solution!**

Tog-L-Loc<sup>®</sup> can join galvanized parts quickly and easily while leaving the Galvanized coating intact. Typical Tog-L-Loc<sup>®</sup> tool life is commonly in excess of 300,000 joints too, which can save you a lot of money over the cost of external fasteners.

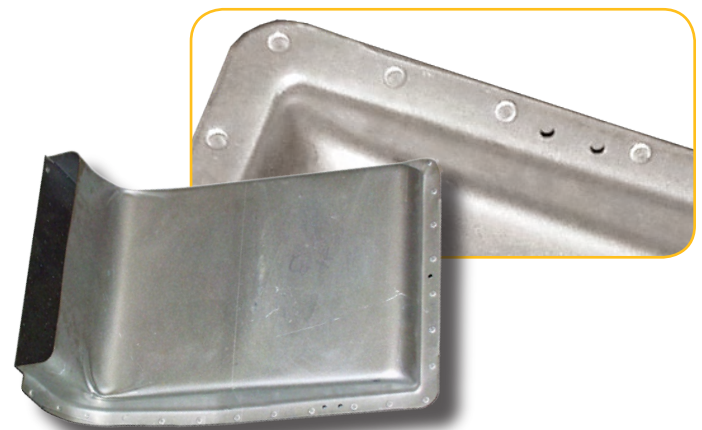
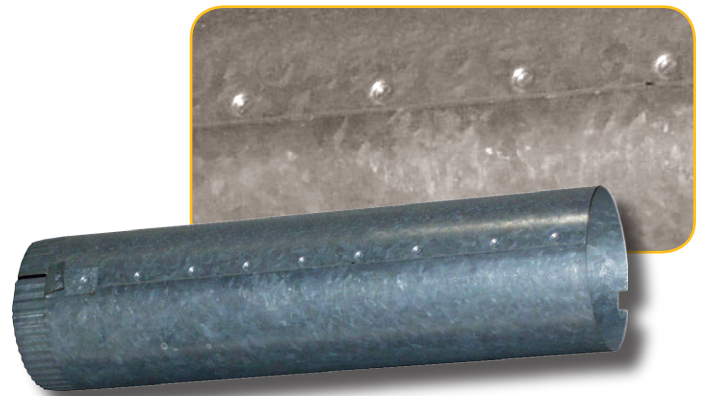



## Tog-L-Loc® in the HVAC Industry

From furnace cabinets to sheet metal ductwork, Tog-L-Loc® can help decrease your assembly costs. A viable & inexpensive alternative to traditional fastening methods, Tog-L-Loc® uses virtually no external fasteners, requires no welds, and produces virtually no scrap which saves you time and money. Furthermore the Tog-L-Loc® process produces strong vibration resistant joints, helping to ensure that your products stay assembled for years to come. Need extra strength? Tog-L-Loc® can be combined with a variety of adhesives to create a stronger joint.

### Is your part Pre-Painted? Aluminum? Something Else?

Tog-L-Loc has been used to assemble components of a wide variety of shapes, sizes, and sheet metal types. From large pre-painted furnace cabinets to tiny components consisting of two different types of metal, Tog-L-Loc® has been utilized with impressive results. Contact BTM Corporation to find out if your part is a viable candidate for the Tog-L-Loc® sheet metal joining system.



### A cost-effective solution for your unique joining situation.

For over 40 years BTM Corporation has been providing high quality, value added solutions to aid manufacturers - from simple press brake tooling to fully automated systems which combine processes, BTM Corporation has a solution to match your budget.

**Contact us today to schedule a  
free sample joining of your part!**

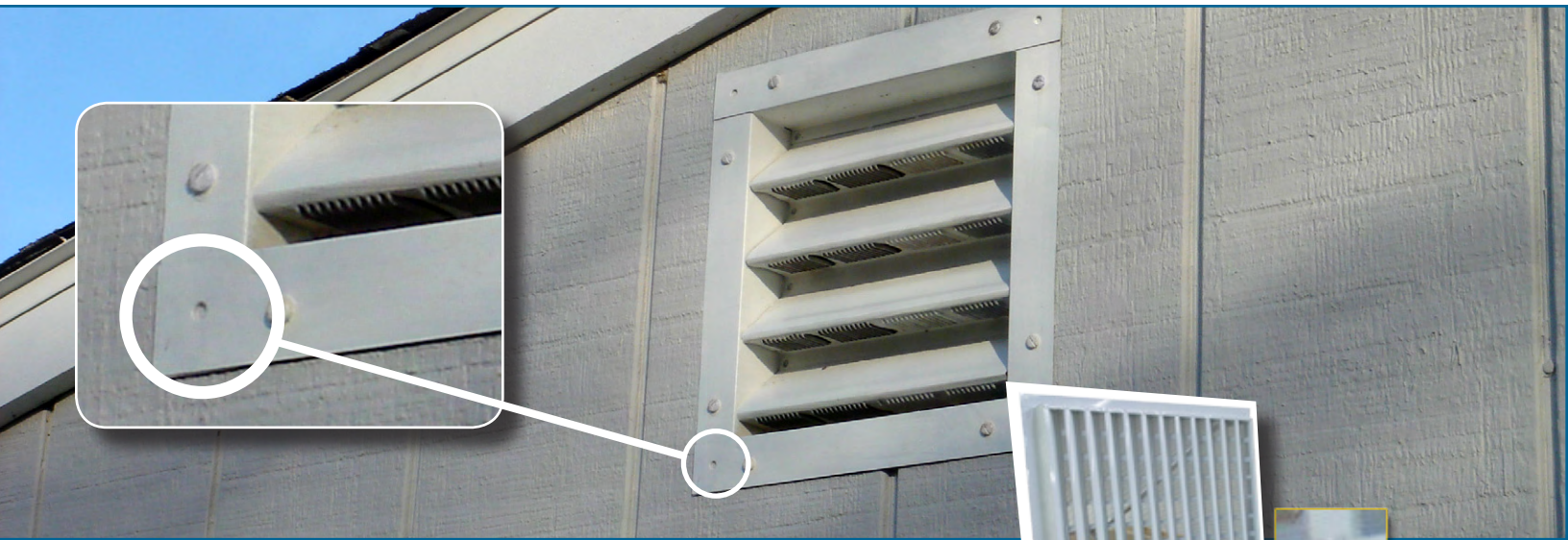

From **Garage Doors** to **Gabled Vents**...

**Tog-L-Loc®** in Construction/Hardware Supply...

Tog-L-Loc® produces strong vibration resistant joints which can be checked non-destructively using a simple gauge or calipers. This saves you money, as does the fact that it is common that Tog-L-Loc® tooling can withstand more than 300,000 cycles before it needs to be serviced. With these features in mind, it is no wonder why Tog-L-Loc® is gaining popularity throughout the industry.

For many years, Tog-L-Loc® has reliably and effectively joined building materials ranging from lighting fixtures, electrical boxes, garage doors, fan housings, and even roll formed sections used in steel frame construction. What makes Tog-L-Loc® so popular in the assembly of building materials? Consistent & leak-proof joints for one, a factor that greatly contributes to the longevity of the joint.

**Lighting Fixture**



**Garage Door**



**Electrical Box**



**Fan Housing**



## Use Tog-L-Loc® clinching on your next project!

With today's competitive environment, reducing production costs is more important than ever, and Tog-L-Loc® can help you do this in two basic ways: Directly, by removing the recurring cost of purchasing external fasteners for your assembly process, and also by offering you cost effective production equipment that will help maximize your efficiency without breaking the bank.

### Versatile tools to simplify your assembly

From fully automated custom designed and built machines to simple hand-operated units, BTM Corporation manufactures an impressive line of products that will allow you to effectively utilize Tog-L-Loc® in your next project. Contact BTM today to find out how one of our many standard products can be adapted to your assembly operation, or how a special machine designed and built by our experienced staff can improve production time, and decrease your assembly costs.



### Garage Door Machine

BTM built this custom machine to assemble garage door components for a leading manufacturer.



Contact us today to schedule a **free** sample joining of your part!

**Satellite Dish**

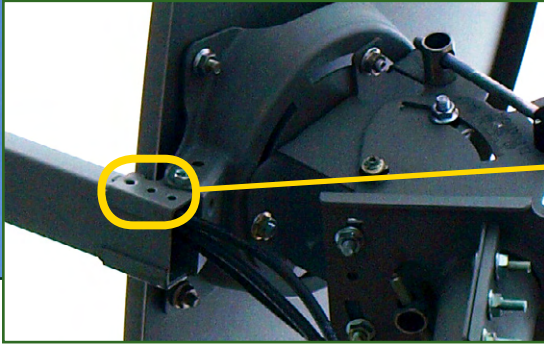

**Computer Case**

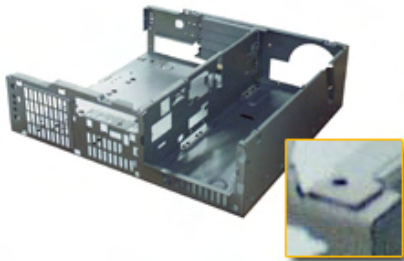

**Electrical Motor - Bearing Support**

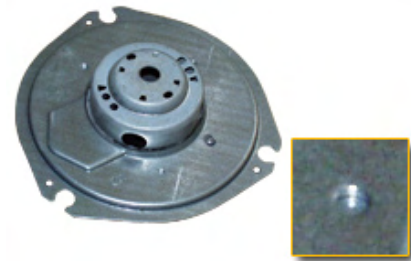

**Automotive Battery Cable**  
*(Dissimilar Metals)*

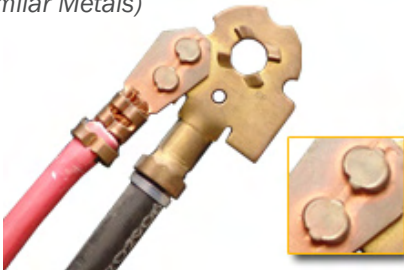

**Television Shield**

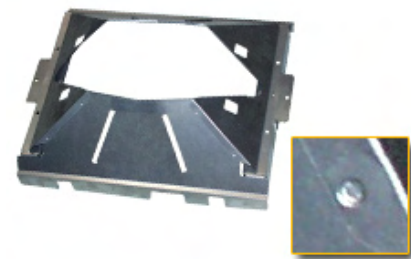

**Computer Power Supply Cabinet**



**Heat Sink**

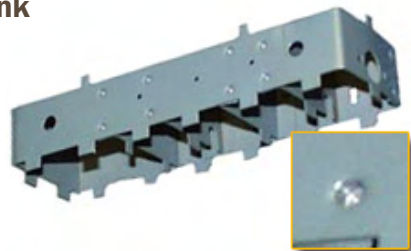

## Tog-L-Loc® in the ELECTRONICS Industry

Electronics are on the forefront of innovation. Few things evolve as quickly and rapidly as electronic technology. The products on the cutting edge of today are outdated relics tomorrow. With such rapid change and product evolution, you need an assembly solution that is easily adaptable and low cost. Tog-L-Loc® may be what you are looking for.

---

### Small Components

These small electronic components feature a dissimilar metal combination joined using special Tog-L-Loc® tooling.

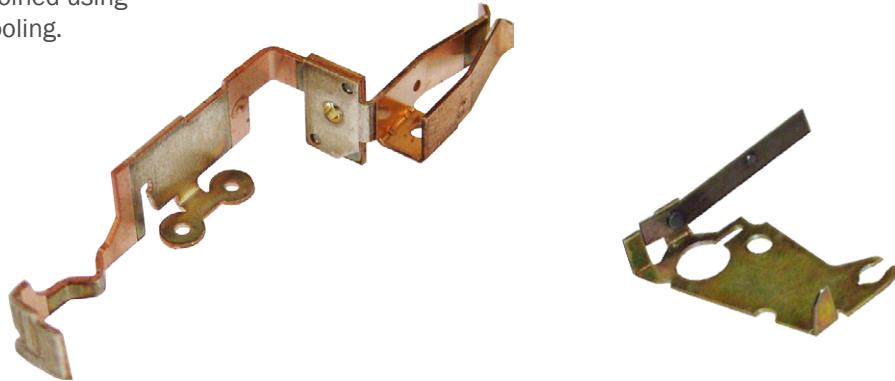

### A solution specific to your unique joining needs..

BTM can provide standard tooling and equipment, or it can build a custom solution for your unique application. Contact BTM today to learn more about our capabilities, and how we can start saving you money in your assembly process.

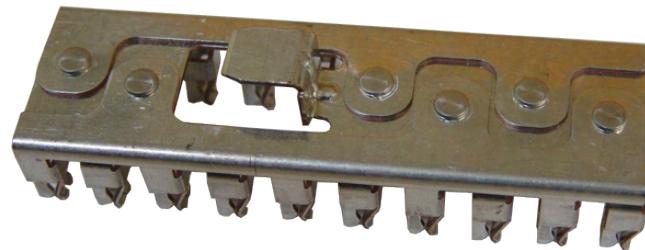

**Contact us today to schedule a *free* sample joining of your part!**

## Is your part **Pre-Painted?**



**Washer/Dryer Shell**



**Dishwasher Frame**



**Refrigerator Shell**



### **How do you fasten your pre-painted sheet metal parts?**

Welding pre-painted surfaces is not practical because the paint gets burned and ruins the aesthetics of the part. Do you use external fasteners? That might work- but each fastener adds a cost to the assembly process which can become significant over the course of a product's manufacturing life. External fasteners may also present the possibility for leaking to occur since a hole is created when a fastener is installed.

Tog-L-Loc® is an economical solution when it comes to assembling pre-painted parts. The process is fast (a typical Tog-L-Loc® joint is created in under 1 second); the tooling typically has a long life (more than 300,000 joints common), and Tog-L-Loc keeps most coated surfaces intact during the joining process. Furthermore, there is no piercing involved in the Tog-L-Loc® process, which means that Tog-L-Loc joints are leak-proof, which can be beneficial, especially in wet environments.

From refrigerator cabinets, to microwave shells; small components to large assemblies- Tog-L-Loc® has been used for many years with great success in the Appliance industry.

The examples shown on these pages are but a small sampling of Appliance products which have used the Tog-L-Loc® clinching process. Contact BTM today to schedule a free sample joining of your unique part.

**Contact BTM today to schedule a free sample joining of your part!**

## Tog-L-Loc® in the APPLIANCE Industry

A viable & inexpensive alternative to traditional fastening methods, Tog-L-Loc® uses virtually no external fasteners, no messy adhesives or welds, and produces virtually no scrap which saves you time and money. Furthermore the Tog-L-Loc process produces strong vibration resistant joints which helps to ensure that your products stay assembled for years to come.

## Looking to reduce weight in your sheet metal assemblies?

Because no fasteners are used, and no materials are added during the joining process, the weight of the assembly remains the same before and after it is clinched. This helps to ensure that your part's initial weight before being clinched is the same weight after it is clinched.

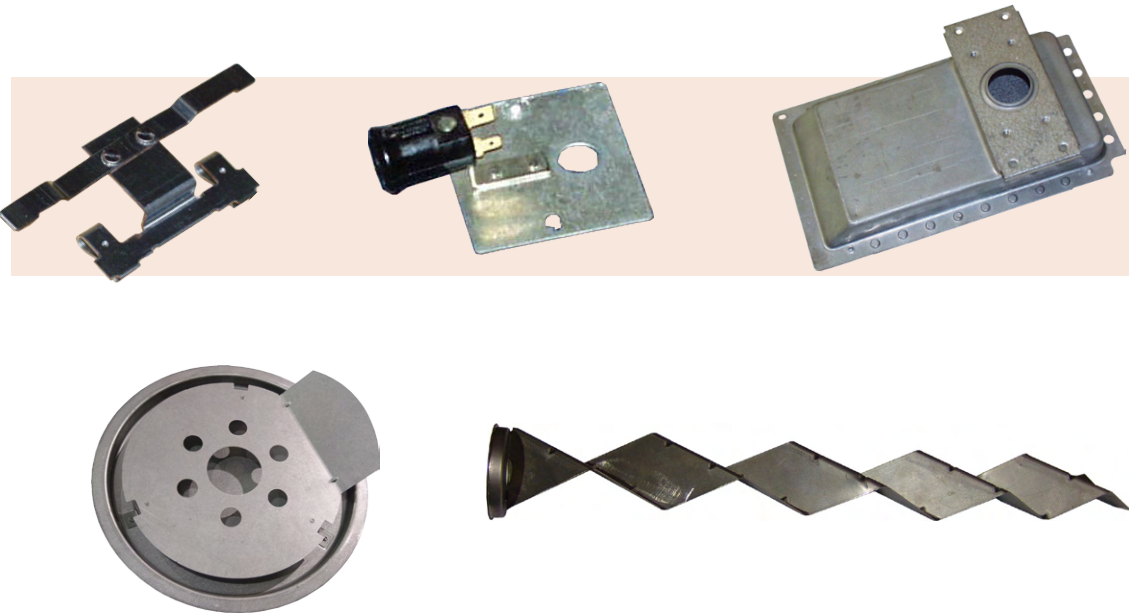

## A solution for your specific needs..

For over 40 years BTM Corporation has been providing high quality solutions to aid manufacturers - from simple press brake tooling to fully automated systems, BTM Corporation has a solution to match your budget.

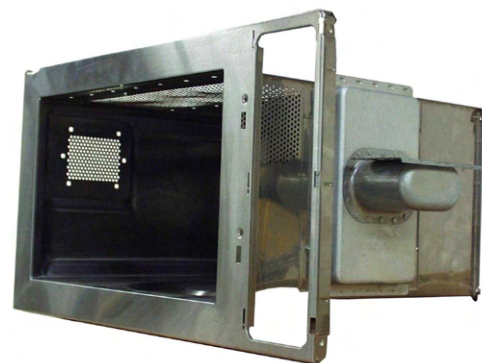

## IS YOUR MATERIAL ABLE TO BE CLINCHED?

Although Tog-L-Loc® has been successfully used for sheet metals that fall outside of this range, a typical mild steel application has a combined material thickness of up to 7.87mm [.310"] and falls between 50-60 on the Rockwell "B" scale.

**Note:** Some materials are too thick, or too hard to be joined effectively with Tog-L-Loc®. However, some of these metals may still be clinched using BTM's Lance-N-Loc™ sheet metal joining system.

See page 22 for more info on Lance-N-Loc™.

In addition to mild steel, Tog-L-Loc® has also been used to clinch galvanized steel, pre-painted steel, aluminum, copper, dissimilar metal combinations, and even some stainless steels. In addition to this, metals with an adhesive layer between them, and even sound deadening steel, have been successfully clinched using Tog-L-Loc®.

Whether or not a material can be clinched depends largely on its ductility, thickness, hardness, and whether or not there is enough room to make a joint.

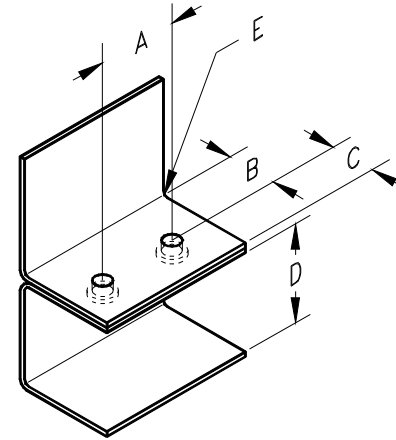

## IS THERE ENOUGH ROOM TO MAKE A JOINT?

Minimum distance requirements for each die listed below.

Tooling		Dim	3.0mm [.12"]	3.8mm [.15"]	4.6mm [.18"]	5.5mm [.22"]	6.4mm [.25"]
 Standard 940 Dies	A*	12.50 [.492"]	14.00 [.551"]	16.50 [.650"]	19.50 [.768"]	22.50 [.886"]	
	B	6.8 [.27"]	7.5 [.30"]	8.8 [.35"]	10.3 [.41"]	11.8 [.46"]	
	C	3.0 [.12"]	3.8 [.15"]	4.6 [.18"]	5.5 [.22"]	6.4 [.25"]	
	D	24.0 [.94"]	28.5 [1.12"]	28.5 [1.12"]	35.5 [1.40"]	40.0 [1.57"]	
	E	0.8 [.03"]	0.8 [.03"]	0.8 [.03"]	0.8 [.03"]	0.8 [.03"]	
 MINI 940 Dies	A*	11.00 [.433"]	12.50 [.492"]	14.00 [.551"]	16.50 [.650"]	21.00 [.827"]	
	B	6.1 [.24"]	6.8 [.27"]	7.5 [.30"]	8.8 [.35"]	11.0 [.43"]	
	C	3.0 [.12"]	3.8 [.15"]	4.6 [.18"]	5.5 [.22"]	6.4 [.25"]	
	D	24.0 [.94"]	24.5 [.96"]	28.5 [1.12"]	35.5 [1.40"]	40.0 [1.57"]	
	E	0.8 [.03"]	0.8 [.03"]	0.8 [.03"]	0.8 [.03"]	0.8 [.03"]	
 3 Blade Elastomer Short Insert Dies	A*	14.73 [.580"]	12.70 [.500"]	14.73 [.580"]	19.05 [.750"]	22.22 [.875"]	
	B	8.1 [.32"]	7.1 [.28"]	8.1 [.32"]	10.3 [.41"]	12.0 [.47"]	
	C	3.0 [.12"]	3.8 [.15"]	4.6 [.18"]	5.5 [.22"]	6.4 [.25"]	
	D	26.0 [1.02"]	26.0 [1.02"]	26.0 [1.02"]	32.0 [1.26"]	35.0 [1.38"]	
	E	0.8 [.03"]	0.8 [.03"]	0.8 [.03"]	0.8 [.03"]	0.8 [.03"]	
 3 Blade Elastomer Style "A" Dies	A*	11.18 [.440"]	12.70 [.500"]	14.73 [.580"]	19.05 [.750"]	22.22 [.875"]	
	B	6.4 [.25"]	7.1 [.28"]	8.1 [.32"]	10.3 [.41"]	12.0 [.47"]	
	C	3.0 [.12"]	3.8 [.15"]	4.6 [.18"]	5.5 [.22"]	6.4 [.25"]	
	D	35.0 [1.38"]	35 [1.38"]	35.0 [1.38"]	35.0 [1.38"]	52.3 [1.38"]	
	E	0.8 [.03"]	0.8 [.03"]	0.8 [.03"]	0.8 [.03"]	0.8 [.03"]	
 2 Blade Dies	A*	14.50 [.571"]	14.50 [.571"]	16.00 [.630"]	18.00 [.709"]	20.30 [.799"]	
	B	5.8 [.23"]	5.8 [.23"]	5.8 [.23"]	6.9 [.27"]	8.4 [.33"]	
	C	3.0 [.12"]	3.8 [.15"]	4.6 [.18"]	5.5 [.22"]	6.4 [.25"]	
	D	35.0 [1.38"]	35.0 [1.38"]	35.0 [1.38"]	38.1 [1.50"]	47.6 [1.88"]	
	E	0.8 [.03"]	0.8 [.03"]	0.8 [.03"]	0.8 [.03"]	0.8 [.03"]	

\* Making Tog-L-Loc® joints with noted minimum distances requires a special stripper block.

PREFERRED



## JOINT STRENGTH AND TOOL SIZE..

Tog-L-Loc® tooling sizes are based on the punch tip diameter. Standard sizes include 3.0mm (.12"), 3.8mm (.15"), 4.6mm (.18"), 5.5mm (.22"), 6.4mm (.25"), and 7.6mm (.30") (Non-Standard sizes are available including 1.5mm (.06") and 2.3mm (.09"). Contact BTM for more information). As a rule of thumb, the larger the joint size, the stronger the joint. Determining the correct tool size for each project depends on factors such as the required joint strength, the type and thickness of the materials being joined, and how much space there is to make a joint.



A joint's strength is determined by its shear and peel values. Joints can be optimized for either shear or peel if required. This is accomplished through testing at BTM.

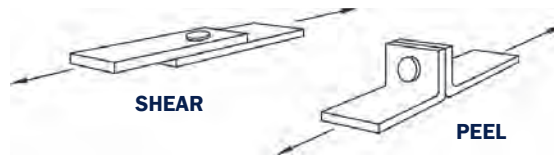

---

## TESTING..

BTM has a test lab in which samples are joined and a variety of data is collected. Once the testing is complete, BTM is able to determine the optimal tool parameters for the application.

BTM generally offers FREE sample joining for parts which qualify. Contact a BTM sales application engineer to find out if your part qualifies for this FREE service.

---

## GETTING STARTED..

Contact BTM Corporation to learn more about Tog-L-Loc®, and to find out if the process may be a viable candidate for your project.

Phone: 810-364-4567  
Fax: 810-364-4125  
Email: [sales@btmcorp.com](mailto:sales@btmcorp.com)  
[www.tog-l-loc.com](http://www.tog-l-loc.com)

300 Davis Road  
Marysville, MI. 48040

**WE CAN PROVIDE YOU WITH THE TOOLS THAT YOU WILL NEED TO**

# SUCCEED

**IN REDUCING ASSEMBLY COSTS.**



## STANDARD TOG-L-LOC® DIE STYLES

Tog-L-Loc® dies are offered in three basic styles: 940 Series, Elastomer, and 2 Blade dies to ensure tooling compatibility with your specific project. 940 dies feature a built in die shield which guards the die blades and elastomer ring. Three bladed Elastomer dies and 2 blade dies are available for tight space requirements. Contact BTM for die holder/mounting information.

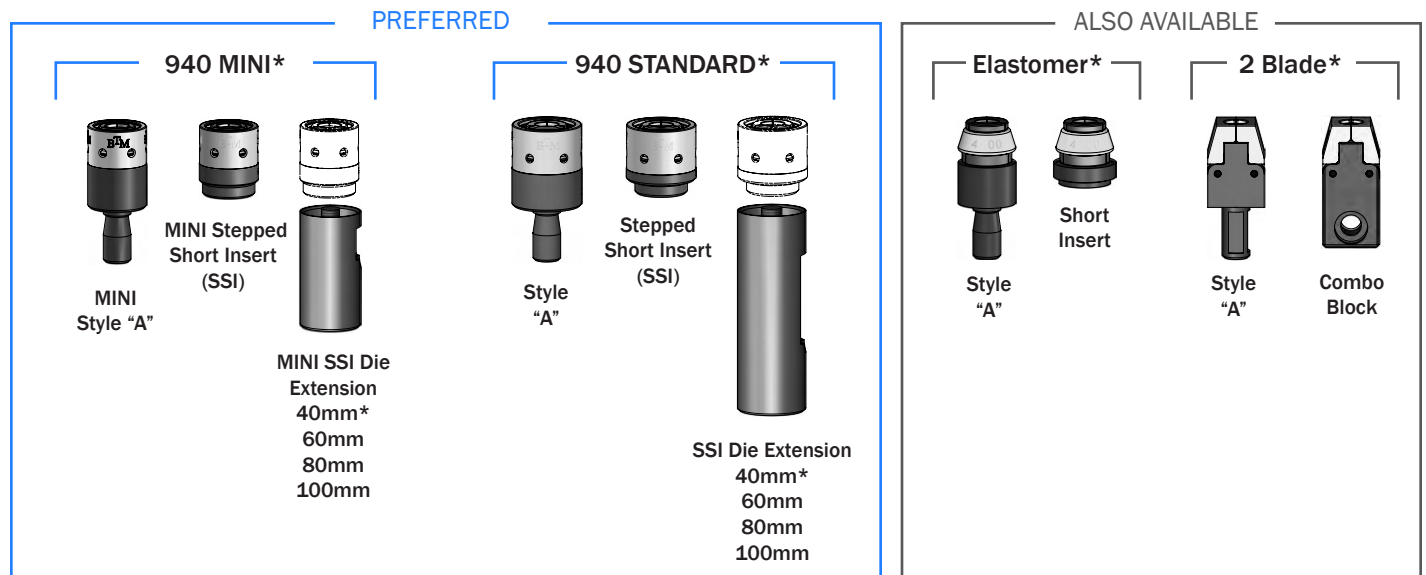

\* Not all die styles available for all joint sizes.

## STANDARD TOG-L-LOC® PUNCH STYLES

Tog-L-Loc® punches are offered in two basic styles: 940, and Ball Lock. The primary difference is the mounting retention. Contact BTM for information on special punches.

### 940 STYLE PUNCH (PREFERRED)

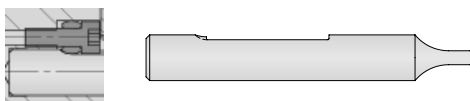

### BALL LOCK PUNCH

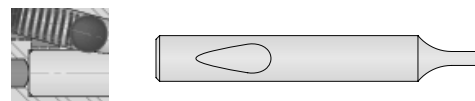

## STANDARD DIE HOLDERS

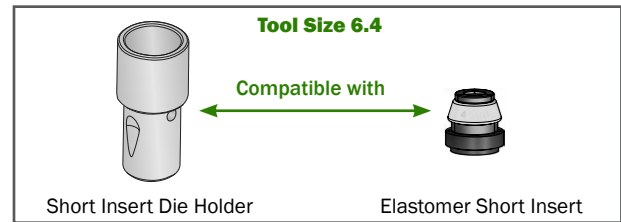
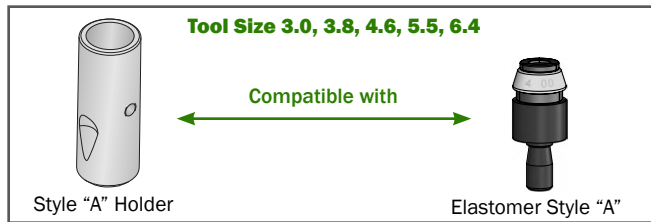
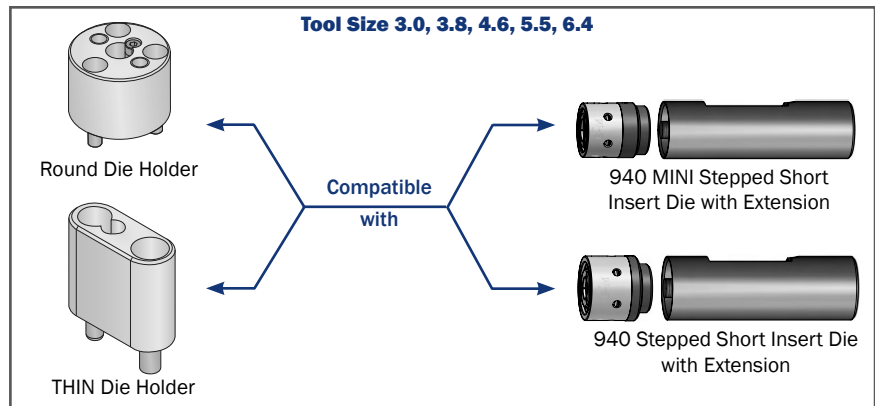
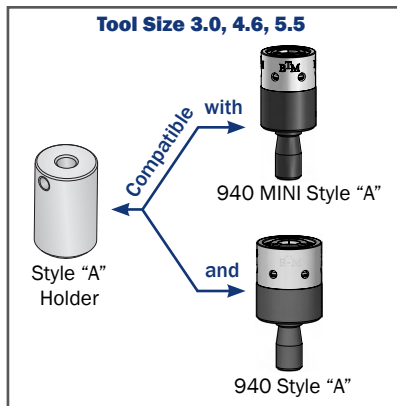

## STANDARD PUNCH HOLDERS

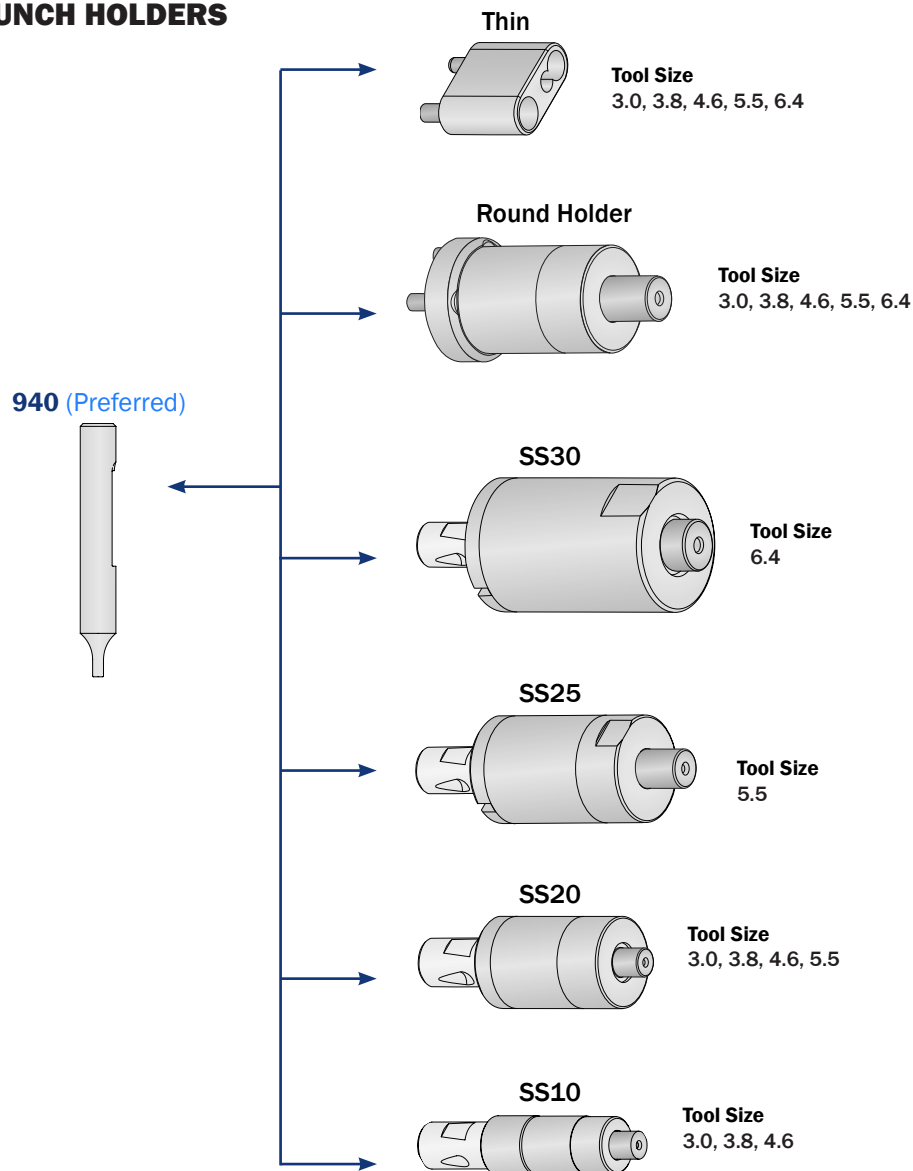

### Press Brake Tooling

BTM offers a variety of press brake tools as a cost-effective way to utilize the Tog-L-Loc® sheet metal joining system in a press.



### Die Sets

Tog-L-Loc® tooling can be inexpensively designed into single or compound motion die set packages. Bump dies can also be provided for joining on sweeps.



### Handheld Units

BTM offers a line of hand held units designed for various joining situations. Pneumatic, Hydraulic, and Self-Contained units are available.



### Universal Presses

The Universal Press is able to easily adapt to join a variety of parts.



### Specialized Units

BTM manufactures a wide range of pneumatic, hydraulic, air/oil, and electrically driven units with single or dual motions for both stationary and robotic applications.



### Special Fixtures

Manually loaded and unloaded dedicated tooling can be built for a single part or a family of parts. Various units are available including Air/Oil, Air Toggle Press, Hydraulic, and more.



## CUSTOM MACHINE SOLUTIONS

BTM believes the success of a machine is derived from the proper application of design knowledge and experience combined with attention to detail. The value of the machine is then measured by the cost to operate it. BTM strives to provide successful and valuable machines to its customers.

### BTM strives to:

- Take an innovative approach to problem solving with an emphasis on cost reduction.
- Use our ability to combine processes such as clinching & clinch fasteners, riveting & feeding, piercing, forming, bending, adhesive dispensing, parts feeding & transfer
- Give attention to detail during project management
- Provide timely response to customer requests
- Accommodate running product design changes
- Make application of our time tested knowledge and experience
- Apply our knowledge of customer specifications

### BTM Service

Should you ever need service for one of our machines, BTM will provide a timely response to your request and provides an afterhours emergency telephone system. Just call our number and you will receive instructions for placing an emergency service request.

The above points combine to provide our customers with a satisfying experience.

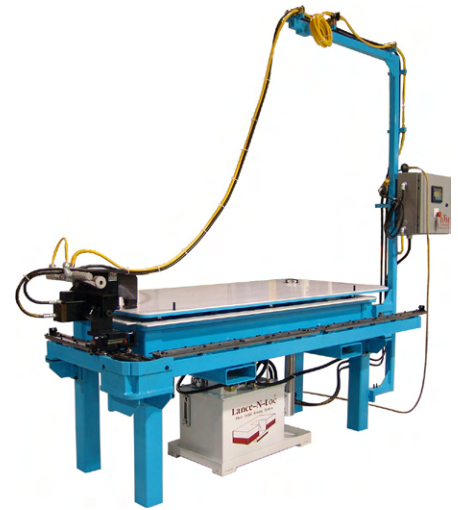

This custom solution uses a BTM 7006 handheld unit, fixed to a track to easily clinch various locations of a part.



This custom dual workstation machine uses Tog-L-Loc® to assemble an automotive part.

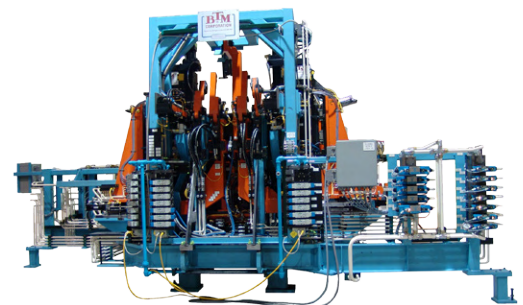

This large custom-built machine was designed to pierce and insert Spac® nuts in an automotive front cradle assembly.

Note: Any absence of guarding and/or safety controls in the photos contained within this brochure, does not absolve the customer from installing and implementing required safety features.

## Other Innovative Solutions for Assembly

In addition to Tog-L-Loc®, BTM can also provide solutions for Lance-N-Loc™ joining, piercing, shearing, dimpling, swaging, and more. Listed below is merely a small sample of our capabilities. Contact BTM to learn more about how we can help you reduce your assembly costs and improve your processes.

### Lance-N-Loc™ SHEET METAL JOINING SYSTEM

Lance-N-Loc™ is commonly used where metals are insufficiently ductile to join using Tog-L-Loc® or in certain dissimilar combinations or multiple layers. BTM's Lance-N-Loc™ Joining System produces clean, strong and consistent joints in most coated or uncoated metals. The joints are characterized by a "button" formed on the die side layer of metal and a recess formed in the punch side layer. The button is a good indicator of joint quality and therefore, simplifies quality control. Two or more layers of metal typically ranging in thickness from .008" (0.2mm) to .157" (4.0mm) per sheet can be reliably joined in most cases.



The first step in the process involves the clamping of the material with a punch side stripper.

#### CLAMPS

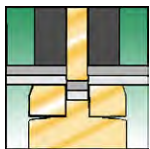

Next, the punch draws the material into the die.

#### DRAWS



As the material flows into the die, the die blades expand, allowing the metal to flow into a strong interlock below the bottom sheet.

#### LOCKS



Punch Side  
of completed joint



Die Side  
of completed joint

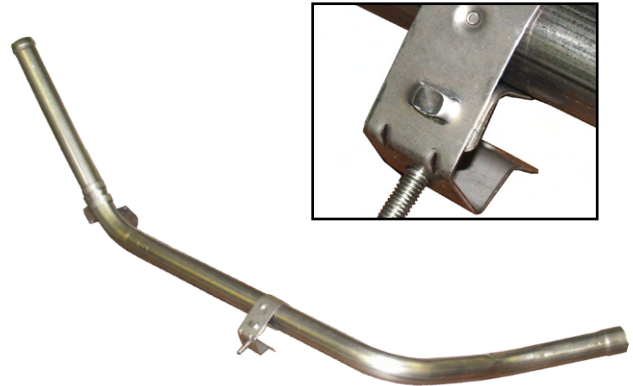

Air Conditioning Tube



Ductwork

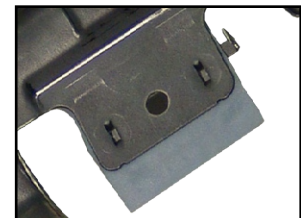

Air Bag Assembly

## Piercing

BTM has the ability to pierce a variety of hole sizes and shapes in a range of materials, including plastics. We offer a range of piercing solutions, from simple units or fixtures to fully automated systems which can combine piercing with multiple other processes. The examples that are shown in this brochure are just a small sampling of BTM's capabilities. Contact BTM for more information.

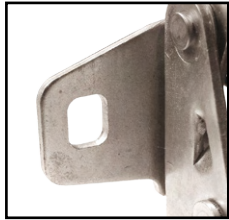

Rectangular Hole



Oblong Hole



Circular Hole  
With Notch

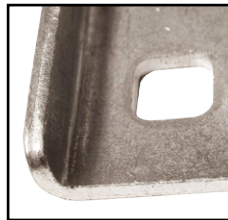

Square Hole

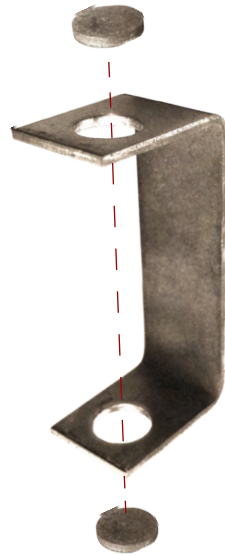

Precise Inline Piercing

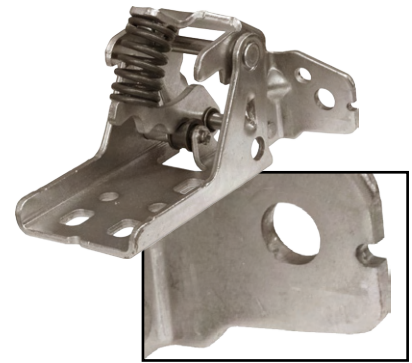

### Hinge Pierce & Notch

Accurate hole location adjustment is accomplished in this heavy gauge steel. Notch location is adjustable for error proofing.

## Shearing

This trunk liner features a notch shear to accommodate a CD changer.



## Swaging

A custom BTM die set is used to swage the tubes into the plate, while keeping it distortion free.

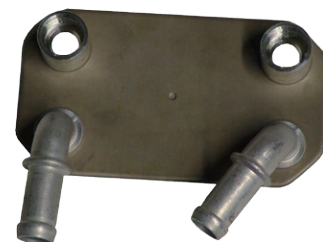

# BTM<sup>®</sup> CORPORATION

BTM has a wide range of standard products to meet your needs including:

## PNEUMATIC CLAMPS & GRIPPERS

### Light & Heavy Duty Clamps

Clamps range from light duty omni-directional head clamps to heavy duty precision sealed power clamps.



### Light & Heavy Duty Grippers

BTM's Gripper line ranges from compact light duty models to locking & non-locking heavy duty models.



## PIN PRODUCTS

### Pin Locator Clamps

BTM's Pin Locator Clamps and Single Finger clamps are used in stationary part nests, welding fixtures, transfer systems, robot end effectors and numerous other clamping applications. These clamps locate and hold the work while other operations are performed.



Standard pin sizes range from 12.5mm - 40mm.

### PLC25 Series Pin Clamps

Compact design, small size pin locator clamps.

Standard pin sizes range from 6mm - 12mm.



## SHEET METAL JOINING

### Tog-L-Loc<sup>®</sup>

BTM's Tog-L-Loc<sup>®</sup> sheet metal joining system is a cold forming process that quickly joins pre-painted, galvanized, coated, and dissimilar metals.



### Lance-N-Loc<sup>™</sup>

BTM's Lance-N-Loc<sup>™</sup> Joining System produces clean, strong and consistent joints in most coated or uncoated metals.



### Ways to Tog-L-Loc<sup>®</sup>



Press Brakes



Handheld Units



Die Sets



Universal Presses



Hydraulic Units



Specialized Units

For more information, or to see our full line of products, please visit:

[WWW.BTMcorp.COM](http://WWW.BTMcorp.COM)